

SPECIFICATIONS

Description	TPC Ultrasonic Cleaner	
Model	UC 250	
Tank Capacity	2500 ml / 2.6 Qt (US)	Max. 2100 ml / 2.2 Qt (US)
		Min. 600 ml / 0.6 Qt (US)
Tank Size	24.5 x 15.0 x 7.6 cm / 9.6" x 5.9" x 3.0"	
Longest Item Fits inside Tank	26.0 cm / 10.2"	
Power Supply	160 W (AC 100~120V 50/60Hz)	
	170 W (AC 220~240V 50/60Hz)	
	130 W (AC 100V 50/60Hz)	
Digital Timer Settings	1 to 30-minute full range timer	
Ultrasonic Frequency	35,000 Hz	
Tank Material	Stainless Steel SUS304	
Housing Material	ABS	
Net Weight	2.9 kg / 6.4 lb	
Gross Weight	3.5 kg / 7.7 lb	
Unit Size	31.4 x 24.3 x 20.4cm / 12.4" x 9.6" x 8.0"	
Inner Carton Size	35.6 x 27.5 x 24.2 cm / 14.0" x 10.8" x 9.5"	
Qty per Master Carton	4 pcs /ctn	
Master Carton Size	57.0 x 37.5 x 51.5 cm / 22.4" x 14.8" x 20.1"	

TPC Ultrasonic Cleaner

Dentsonic UC 250

USER MANUAL

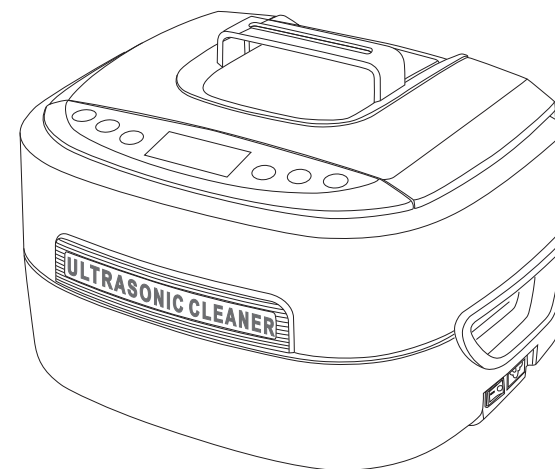

FEATURES

- 1 Lengthened tank** Tank capacity: 2500 ml / 2.6 Qt; Size 24.5x15.0x7.6 cm / 9.6"x5.9"x3.0". Longest item that can fit is 26.0 cm / 10.2"
- 2 Control panel with capacitive sensing technology** Durable, reliable, resistant to water and harsh chemicals
- 3 Industrial ultrasonic transducer** Φ 38mm industrial transducer(60W),with stronger cleaning effect
- 4 2-color LED display** 1 to 30-minute full range timer, degas feature
- 5 Ceramic heater** 100W ceramic heaters
- 6 Multiple circuit protectors** When overloaded or improperly used, the protectors shut down the power to certain areas to protect the machine
- 7 Cooling fan** Improves heat dissipation and beneficial for continuous operations
- 8 Detachable power cord** Independent power switch and detachable power cord, convenient to use
- 9 Moisture-proofed PCB and industrial grade IC** Capable for different working environment with better anti-interference performance
- 10 Engineering grade plastics** 4mm wall thickness with tongue and groove joints, with better impact and water-proof performances

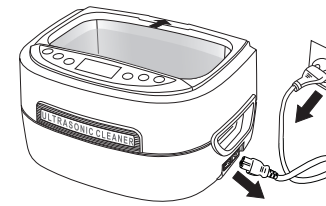

5 When cleaning is completed, turn off the switch, remove the lid and retrieve the items. Pour water out through the pouring recess. Clean and wipe the tank dry.

CARE AND MAINTENANCE

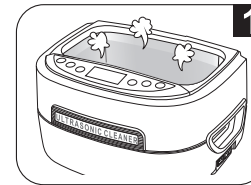

Do not turn on the unit without water in the tank. Even though the unit is designed with multiple protections, if it is turned on for over 30 seconds without water in the tank, it may damage the unit or severely reduce the life of the unit. If heating over 3 minutes, it will damage the heater.

 This unit is equipped with a thermal cutoff. If the cleaning function is turned on without water in the tank, the temperature will rise continuously. The thermal cutoff will be actuated after approximately 15 minutes respectively to ensure safety. The unit will be disabled until it's repaired.

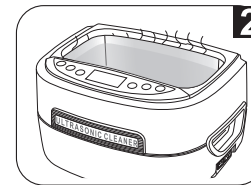

Do not run the unit for extended time or continuously. The unit is designed with overheat protection. If the unit has been running for 45 minutes, it is recommended to stop the unit for about 20 minutes to prolong the life of the unit.

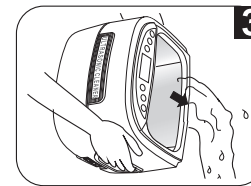

Do not keep water in the cleaning tank for a long time. After cleaning is completed, turn off the switch then pour water out through the pouring recess. Avoid getting water inside the housing through the vents and causing damage.

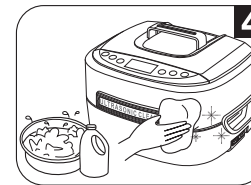

Do not spray water over the housing. Use a towel to wipe the tank and the housing.

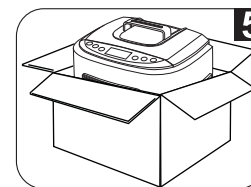

Do not expose the unit under direct sunshine for a long. Keep the unit in a dry, cool and ventilated area.

OPERATION GUIDELINES

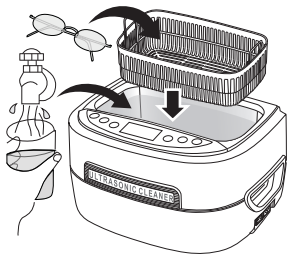

- 1 Remove the lid, put the items in the basket then put them in the cleaning tank. Add water to a level between MIN and MAX and above the area to be cleaned.



If the unit is turned on without water, ultrasonic energy will not be absorbed. Once over 30 seconds, it may damage the unit or severely reduce the life of the unit.

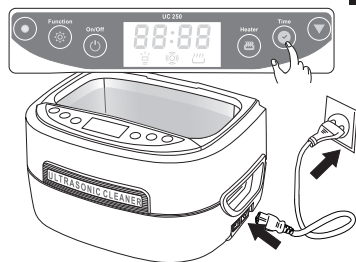

- 2 Connect the power cord to an outlet and turn the switch on. LED display shows **05:00**. This is the most

commonly used time setting and working state. If the time needs to be adjusted, press Time button and ▼ button. The time can be set between 1 to 30 minutes. Common cleaning time are 5, 10 or 15 minutes.

Prolonged cleaning time may result in:

- a. Loosening of the screws if used.
- b. Increasing the pre-existing cracks.
- c. Peeling of coating which was already separated.

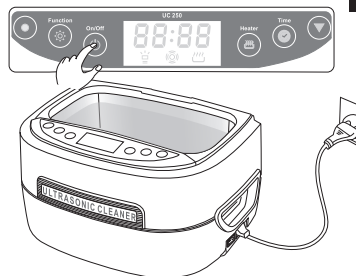



- 3 Press On/Off button to start cleaning.

During cleaning, buzzing sound can be heard from the cleaning tank, indicating the cleaning is underway. Closing the lid will reduce the noise.

LED display will count down to show the remaining cleaning time. When it displays **00:00**, the cleaning is done. To stop cleaning at any time, press On/Off button.

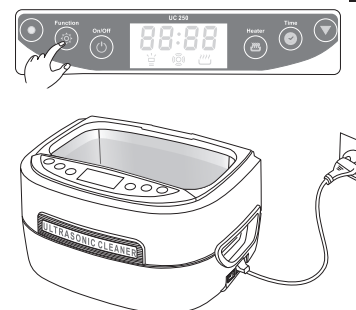
The unit is designed with overheating protection to avoid damage caused by extended and continuous operation. When the red light is on, the unit will not turn on even it is forced to. The unit will idle for about 20 minutes then can be restarted after the green light comes on.



- 4 Select one of the four cleaning methods recommended earlier.
 - a. When the heater is needed, press Heater button,  flashes, indicating the heater is turned on. When water temperature reaches 60°C (140°F) the heater will turn off automatically.

To ensure safety, the unit is designed with dual protections. The heater will be turned off automatically if it has been running for 45 minutes.

- b. To speed up the mixing when solution is used, degas function can be used. Press Time button to set the timer. Press Function button,  illuminates. Press On/Off to start degassing. It changes over to normal cleaning after 90 seconds.
- c. When debris "smoke" is no longer visible, cleaning is done. If additional cleaning is needed, press Time button to reset the timer and repeat the steps above.

INTRODUCTION

Use tap water. Special solutions are not necessary in most cases.

Principles of ultrasonic cleaning:

Millions of tiny air bubbles are generated within liquid by high frequency vibration. The air bubbles burst when in contact with object and dislodge the debris to achieve the cleaning effect.



- Using tap water is sufficient. Purified water or distilled water has the same cleaning effect as regular tap water for ultrasonic cleaning.
- When cleaning silver or copper items where oxidation has darkened the items, special solutions needs to be added to the water to remove the oxidation.

Main Features

- Tank capacity: 2500 ml / 2.6 Qt . Size: 24.5x15.0x7.6 cm / 9.6"x5.9"x3.0". Longest item that can fit inside the tank is 26.0 cm / 10.2".
- Use stronger industrial grade $\Phi 38$ ultrasonic transducer (60 W), good clean effect.
- Control panel with capacitive sensing technology: Durable, reliable, resistant to water and harsh chemicals .
- Ceramic heater (about 100 W) 65 °C temperature limited.
- 2-color LED display. 1 to 30-minute full range timer. Degas feature.
- Industrial grade IC. Moisture-proofed PCB. Cooling fan. Thermal cutoff, overheat protector, internal safety timer for heater. Improved product durability.
- 4 mm wall thickness with tongue and groove joints for better impact and water-proof performances.

Read the Manual First

The manual should be carefully reviewed before starting to use the device. Warnings should be observed carefully. Please follow the manual for operations.

TABLE OF CONTENTS

Safety Precautions -----	1,2
Product Explosion Picture -----	3,4
Product Structure and Accessories-----	5
Control Panel and Operations -----	6
Operation Guidelines -----	7,8
Care and Maintenance -----	8
Specifications -----	9

SAFETY PRECAUTIONS



Keep it away from children!

-  **This appliance can be used by children aged from 8 years and above if they have been given supervision or instruction concerning use of the appliance in a safe way and if they understand the hazards involved. Cleaning and user maintenance shall not be made by children unless they are aged from 8 years and above and supervised. Keep the appliance and its cord out of reach of children aged less than 8 years.**
- Please store the ultrasonic cleaner where it is not reachable by children.
- Danger to children! Danger for death through suffocation! Keep the packaging material away from children.
- This appliance shall not be used by children. Keep the appliance and its cord out of reach of children.



To prevent life-threatening electrical shock, please observe the following:



Danger of electrical shock! Do not use while bathing. Never immerse the device or the power cord in water or other liquid.

- **Danger of electrical shock!** Never touch the power plug with wet hands, especially when inserting or removing the plug.
 - **Danger of electrical shock!** If the unit has fallen into water during operation, do not touch the unit. Remove the power plug from the socket first.
 - **Danger of electrical shock!** Do not spray water or liquid over the device.
 - Never operate the device unattended.
 - Follow the manual to operate the device.
 - Do not use components unapproved by the manufacturer.
 - When removing the power cord from the socket, grab the power plug not the cord.
 - To protect the power cord from damage, do not cause it to get caught by things such as a cupboard door or a chair leg; do not drag across a hot surface.
 - If there is damage to the power plug, cord, housing, or other parts of the device, do not use the device.
 - Do not disassemble the device, except by professionals.
 - If the unit is damaged, non-operational or has fallen into water, take it to a qualified service provider.
 - Remove the power plug from the socket
 - if malfunction occurs
 - before cleaning the device
 - if the device is not going to be used for prolonged period
 - after each use (recommended)
 - The installation of an earth leakage circuit breaker with a rated tripping current of no more than 30 mA provides further protection against an electrical shock. The installation should only be carried out by a trained electrician.
-  **To prevent fire hazards, please observe the following:**
- Never block the vents on the device. Keep the vents free from lint, hair and other materials.
 - Do not place the device on a soft surface, such as a bed or a couch, where the vents could be blocked.
 - Observe the other warnings in the previous section.
 - If the supply cord is damaged, it must be replaced by the manufacturer or its service agent or a similarly qualified person in order to avoid a hazard.



CONTROL PANEL AND OPERATIONS

1. Indicator Light - Working Status

Green - Normal working status, ready to use.

Red - Under overheat protection. 15 minutes of waiting time is needed for the light to change from red to green. Work can resume afterwards.

2. Function Button - Functions (Degas/Normal)

Press Function button,  illuminates, indicating Degas function is selected. Press On/Off button to start degas.  will flash for about 90 seconds, then the unit will return to normal cleaning function. Pressing Function button before it ends will stop degassing. If additional degassing is needed after it ends, press Function button again.

Degas

When cleaning heavily soiled or greasy items, silver, copper or brass items, chemical solutions need to be added into the water. The solution may form many small droplets and take a long time to dissolve in the water. Newly added water may generate many air bubbles on the tank walls. These will reduce the cleaning effect in the beginning phase of ultrasonic cleaning. Turning on the degas function will dissipate the droplets and the air bubbles, usually in 90 seconds, and improve cleaning efficiency.

3. On/Off Key - On/Off Switch for the Unit

After powering on, the LED displays  which is the default time and the unit is ready with normal working status.

Press On/Off button once and the cleaning starts. The cleaning stops when the timer counts down to . If the unit needs to be stopped before the timer runs up, press On/Off button.

4.  Digital LED display of working time. It counts down after work being started.



5. — Degas Status



 — Illuminated, the degas function is selected.  — Flashing, degassing is underway.



6. — Normal Cleaning Status

 — Illuminated, normal cleaning is underway.

7. — Heater Status

Press Heater button,  flashes, indicating the heater is turned on. Press Heater button again,  dims, indicating the heater is turned off.

8. **Heater Button** — Heater button. Pressing Heater button,  flashes, indicating the heater is turned on. To cancel heating, press Heater,  dims, indicating the heater is turned off.

9. **Timer Button** — Timer quick set button. Press Timer button, LED display shows . Pressing it again to Timer it to . Each pressing makes it to increase by 5 minutes.

10. **▼ Button** — Timer decreasing button. Each pressing reduces the timer by 1 minute.

PRODUCT STRUCTURE AND ACCESSORIES

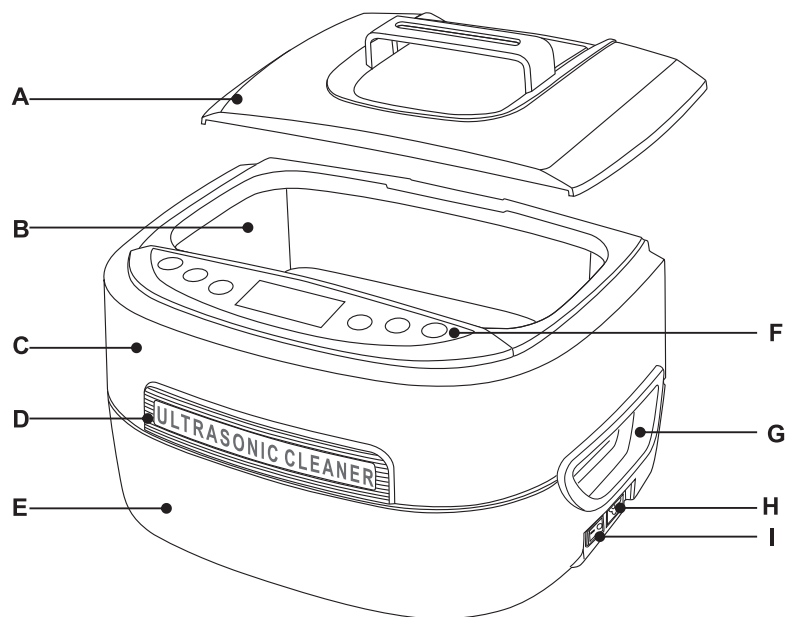

- A.** Top cover
- B.** Stainless steel tank
- C.** Top housing
- D.** Logo block
- E.** Bottom housing
- F.** Control panel
- G.** Handles
- H.** Power socket
- I.** Power switch



Power cord

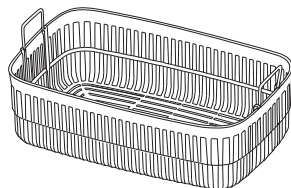

Plastic basket

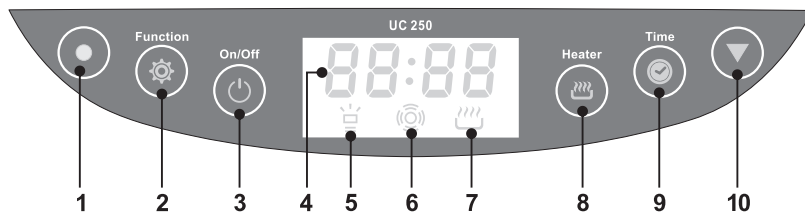

SAFETY PRECAUTIONS



Other observations:

- Do not operate the product without filling the tank with water. Running dry will damage the unit.
- Do not plug in the power cord before adding water to the tank. Do not fill the tank above the Max line to avoid overspill.
- Do not use solution containing abrasive substances or strong corrosive chemical solution not recommended by the manufacturer or the supplier.
- Place the device on a dry and flat surface for operation.
- When the device is subjected to severe electromagnetic interference, it may malfunction, stop operating or lose control functions. If this happens, unplug the power cord then reinsert it to restart the device.

IMPORTANT SAFETY INSTRUCTIONS



When using electric appliances, basic precautions should always be followed, including the following :

- Read all the instructions before using the appliance.
- To reduce the risk of injury, close supervision is necessary when an appliance is used near children.
- Only use attachments recommended or sold by the manufacturer.
- Do not use outdoors.
- To disconnect, turn all controls to the off (O) position, then remove plug from outlet. Do not unplug by pulling on cord. To unplug, grasp the plug, not the cord. Unplug from outlet when not in use and before servicing or cleaning.
- To reduce the risk of electrical shock, do not put the appliance in water or other liquid. Do not place or store appliance where it can fall or be pulled into a tub or sink.
- All servicing of this product, including transducer replacement, is to be conducted by qualified service personnel.
- Do not operate any appliance with a damaged cord or plug, or after the appliance malfunctions or is dropped or damaged in any manner. Return appliance to the nearest authorized service facility for examination, repair, or electrical or mechanical adjustment.



Items Not Suitable for Ultrasonic Cleaning

<p>Soft Jewelry: Pearls, emerald, ivory, coral, agate, sea turtle shells, etc</p>	These items are not hard, so scratches may occur during cleaning.
<p>Welded, Plated and Glued Items: Welded or plated metal items, glued items</p>	Ultrasonic cleaning may enlarge the gaps inside the welded joints, plated coating or glued items and may cause separation.
<p>Watches: Except diver's watches with depth rating over 50 m (150 ft) .</p>	Because the strong penetration capability of the ultrasonic waves, water may get into the watches if they are not truly waterproof. Use the watch stand supplied as a precaution if not sure.
<p>Others: Wood; coated glass, ceramic, camera filters with preexisting cracks.</p>	Ultrasonic cleaning may enlarge the cracks pre-existed in the coating on the glasses, ceramic, and glass. If the items have no pre-existing cracks, then it is okay.

PRODUCT EXPLOSION PICTURE

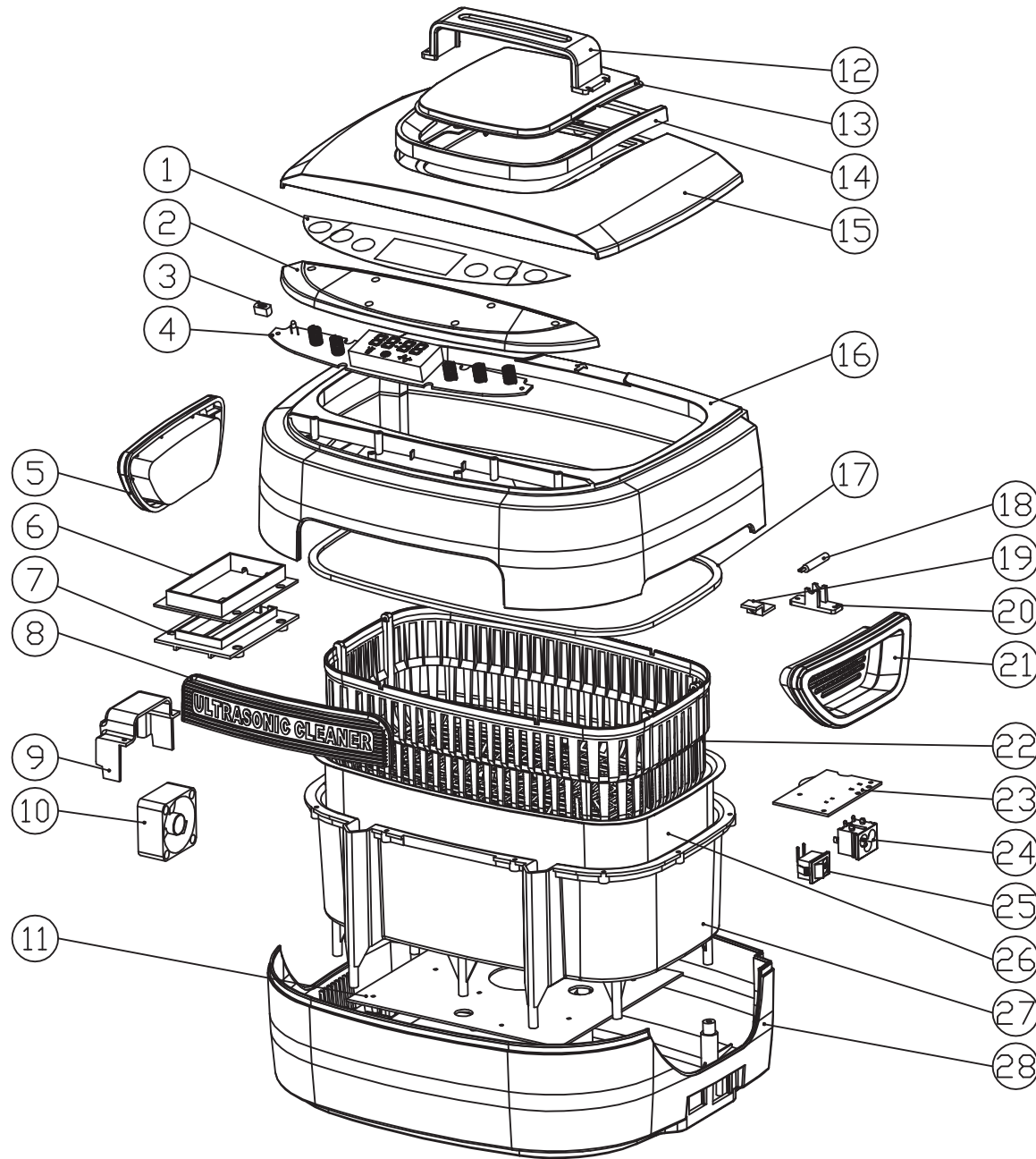

No.	Item	Material
①	Panel surface	PC
②	Control panel box	ABS
③	Light socket	ABS
④	Button pad	94V0
⑤	Left handle	ABS
⑥	Heater pocket	PA 66
⑦	Heater cover	PA 66
⑧	Logo block	ABS
⑨	Cooling fan socket	ABS
⑩	Cooling fan	Standard part
⑪	Power PCB	94V0
⑫	Stainless steel handle	SUS 304
⑬	Lid-window	AS
⑭	Lid top holderwindow bracket	ABS
⑮	Lid	ABS
⑯	Top housing	ABS
⑰	Silicon seal	Silicone rubber
⑱	Thermocouple	Standard part
⑲	Thermal cutoff holder	ABS
⑳	Thermocouple holder	ABS
㉑	Right handle	ABS
㉒	Plastic basket	ABS
㉓	Power switch	94V0
㉔	Power socket	Standard part
㉕	Power switch	Standard part
㉖	Stainless steel tank	SUS 304
㉗	Inner tank	ABS
㉘	Bottom housing	ABS