

TPC



Radiant LED Operatpry Light

Instructions



Radiant LED Operator Light Quick Reference Installation Guide

ASSEMBLING THE HEAD TO THE ARM

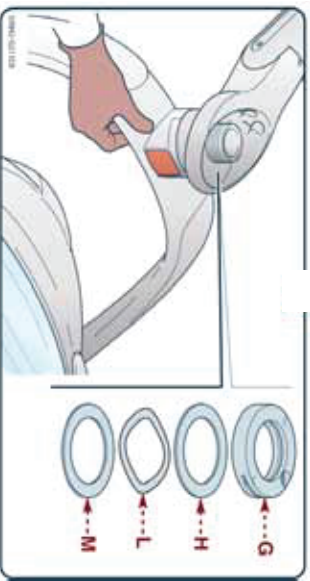

Follow the assembly sequence of the ring nut and washer indicated in the picture.

Proceed according to the description given

- Support the head and insert the washers (H), (L), (M).
- Screw the ring nut (G).

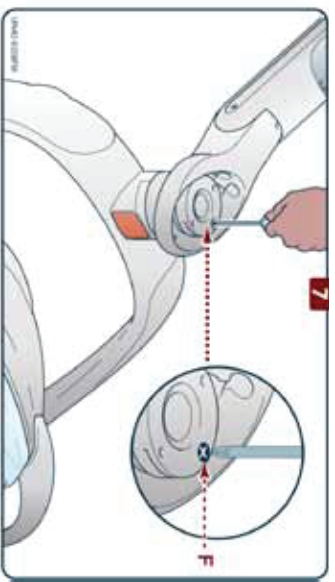

Tighten the safety screw (F) until the proper head rotation resistance is obtained.

ELECTRICAL CONNECTIONS

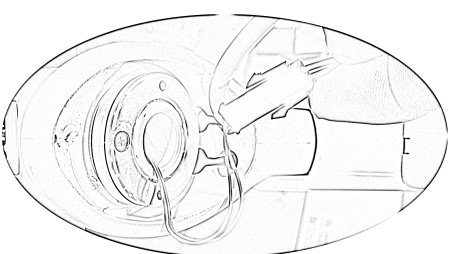

Connect wires as shown.

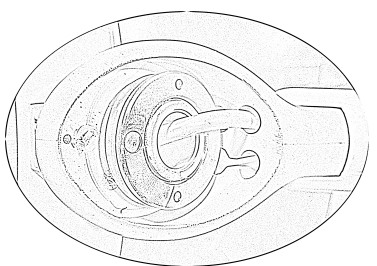

Feed excess wire back into light head.

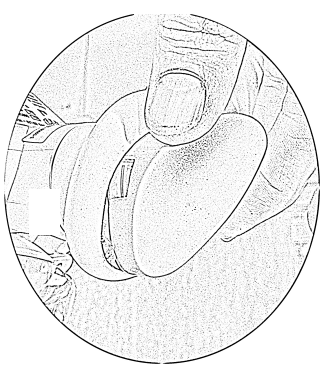

Install cover cap and secure with supplied screw.

Light Handles

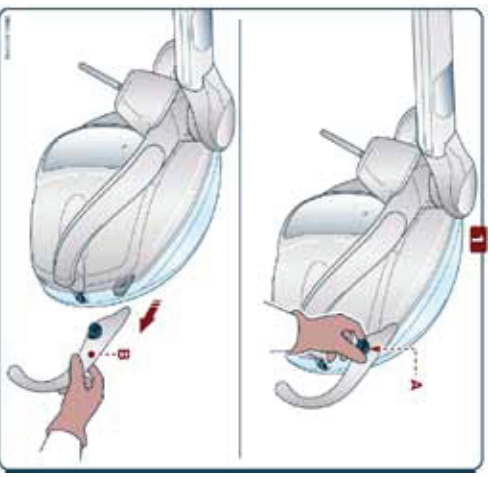

Switch on / off / Adjustment
 - To switch the lamp On and Off, press and release the switch to the LEFT or RIGHT side.
 When the lamp is switched On / Off, the device will beep (once).
 DON'T push and pull the switch. It only moves in a left and right direction.

Right & Left Light handle

Light switch toggle extension

Light shield wrench

Tension nut / brass spanner nut

Signature _____ Date _____

CONTENTS

Symbols.....	page	2
Safety regulations.....	page	4
Features	page	8
Installation.....	page	10
Instructions for use.....	page	11
Maintenance/Cleaning	page	14
Periodic checks	page	16
Technical specifications	page	17
Overall dimensions and range....	page	18
Wiring diagrams.....	page	19

SYMBOLS



DANGER

The paragraphs marked with this symbol contain instructions which must be followed carefully to avoid damaging the device, the operator and the patient.



WARNINGS

These instructions warn the operator that it is mandatory to operate with utmost care to avoid situations which could damage the device.



RESTRICTION

This icon indicates the most appropriate behavior to avoid damaging the device.



RECOMMENDATIONS

This icon indicates useful details for an effective use of the device.



Dispose of the device according to the regulations on separate waste collection of electrical equipment. Directive WEEE 2012/19/EC



Class II device.



Danger warning symbol



Refer to the documentation enclosed..

ATMOSPHERIC PRESSURE

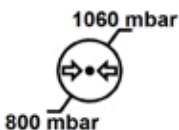

RELATIVE HUMIDITY

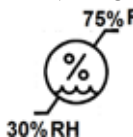

TEMPERATURE

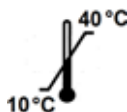

SWITCH SYMBOLS



**ADJUSTMENT
SENSOR**



ON



OFF



SERIAL NUMBER



ITEM CODE



STERILISATION

SYMBOLS ON THE PACKAGING



THIS SIDE UP



FRAGILE



KEEP DRY



DO NOT ROLL



DO NOT USE HANGERS

Fig Max



MAX STACKABLE WEIGHT

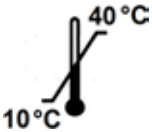

**STORAGE TEMPERATURE
SHIPPING CONDITIONS**

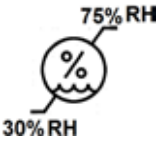

RELATIVE HUMIDITY

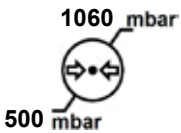

ATMOSPHERIC PRESSURE



RECYCLABLE CARDBOARD BOX

SAFETY REGULATIONS

REGULATORY FRAMEWORK

THE DEVICE IS TO BE USED TO ILLUMINATE THE OPERATIVE FIELD IN DENTAL OPERATIONS. IN NORMAL USE CONDITIONS, THE DEVICE IS ASSEMBLED WITH AN ARTICULATED ARM POSITIONED OVER THE PATIENT'S BODY AT 700MM; THAT IS THE DISTANCE FOR WHICH THE LIGHTING FEATURES HAVE BEEN DESIGNED..

- **The intended user of the device is the dentist and the nurse The intended user of the device is the dentist and the nurse.**
- **Educational qualification:**
 - Bachelor of Dental Medicine
 - Bachelor of Dentistry
 - Dental hygienist
- **Minimum qualification**
 - According to the educational qualification
- **Language understanding degree**
 - According to the educational qualification
- **Expertise**
 - As required by the profession
- **Possible disability of the user**
 - The user must be able to fully use one of his upper limbs
 - Vision mpatible with the profession
- The device can be powered from the dental unit or from a power supply connected directly to the mains (see technical specification paragraph).
- This is not a life support device.
- The device, after being assembled to the arm, is handled by the user to obtain the most suitable work position of the head. The device is usually fitted to the dental unit, but it can also be installed on special applications.
- The light intensity can be adjusted by the user.
- The device has to be cleaned prior to use (see “Cleaning the device” paragraph).
- The head packaging provides the suitable protection and prevents external agents from entering.
- Do not use the device in case one of its components is damaged.
- Installation of the device can be performed by qualified personnel only.
- The head must be installed on a specific control and supply device, such as a dental unit or with an **electrical system that complies with standard IEC 60364-1 and “national regulations for installation of electrical systems in areas for medical use”**.
- The device must be installed with an omnipolar shut-off switch that disconnects it from the mains, according to IEC 61058-1.
- The installer is in charge with preserving the conformity of the device to the IEC 60601-1 standard.
- Ensure the voltage supplied matches the value indicated on the rating plate.
- PFor cleaning plastic parts do not use detergents which contain: AMMONIUM HYDROXIDE – SODIUM HYDROXIDE – METHYLENE CHLORIDE – METHYL ALCOHOL. Failure to follow this indication could cause: RISK OF BREAKAGE OF PLASTIC PARTS. In case of doubts, refer to TPC Customer Assistance.
- Do not perform any maintenance on the head when the power is on: unplug the power cable from the mains prior to any intervention.
- Do not fix or point the light directly into the eyes of patients, especially for those with increased eye injury risk (e.g. children with eye condition). In this case use always the suitable protections and precaution.

- The TPC goggles protect the eyes **of the patient** from possible photobiological hazards. TPC recommends the usage of such goggles especially on particularly exposed patients such as children or adults with eye condition or under photosensitive medication. The goggles have to be worn for the whole duration of the treatment. Prior or after use, clean and disinfect them to prevent cross-contamination. They can only be sterilized at 121°C. Possible scratches and / or halos do not compromise their effectiveness. Do not use the in case of mechanical failures.
- Do not spray detergents-disinfectants directly on the head.
- Do not use the device with accessories which have not been specified in this manual.
- Identification plate affixed to the rear arm of the device.
- The identification plate indicates the Serial No. (SN) the year (AA) and product range of the dental light (LD) and the progressive number (NNNNNN) e.g.: **SN14LD000001**
- The device is not suitable for installation in explosive atmosphere or with high levels of oxygen.
- The dentist must use disposable safety equipment on lamp handles or sterilize them after each patient.
- Unsuitable performance of the device does not compromise patient's safety.
- For surface sanitization use hydroalcoholic disinfectants. (See maintenance /cleaning paragraph).
- Dismantling and disposal of materials should be carried out in accordance with the national standards in force, by contacting, if necessary, special waste disposal centers acknowledged and authorized.
Divide the materials according to the type (ferrous, rubber, plastic etc.). Directive WEEE 2012/19/EC.
- Do not leave small parts of the equipment unattended or at reach of persons (children), since they represent potential hazards.
- Do not carry out maintenance or replacement operations on parts other than those indicated in the manual. Any intervention which has not been indicated in the manual could compromise the device safety.
- Perform only the operations given in the manual; otherwise contact the technical assistance.
- TPC forbids all modifications of the device, unless expressly authorized, in written, under penalty of voiding safety regulations conformity and warranty.
- The device, in its original packaging, can be shipped or stored for 15 weeks under the following environmental conditions:
 - **Ambient Temperature from -20°C to + 70°C**
 - **Relative humidity from 10% to 90%**
 - **Atmospheric Pressure from 500 to 1060 mbar**
- The device must be used under the following environmental conditions:
 - **Temperature from 10°to 40°C**
 - **Altitude max: 2000 m**
 - **Relative humidity from 30% to 75%**
 - **Atmospheric Pressure from 500 to 1060 mbar**

SAFETY REGULATIONS

REQUIREMENTS FOR ELECTROMAGNETIC COMPATIBILITY

This section contains specific information related to the product's compliance to the standard IEC 60601-1-2: 2007. The dental head EDI LED it's an electro-medical device which requires particular precautionary measures to ensure electromagnetic compatibility; it must be installed and used according to the information provided in the documentation supplied with it. Mobile and portable RF communication equipment (mobile phones, radio transceivers, etc.) can influence the medical system. The use of accessories, transducers and cables supplied by the manufacturer of the equipment and of the system as spare parts, can increase the emissions or a decrease the immunity of the equipment or systems.

Manufacturer's guidelines and declaration – Electromagnetic emissions

EDI LED head is designed to operate in electromagnetic environments according to the specifications below. The client or user has to make sure the device gets actually used in such environment

Emissions tests	Conformity	Environment Electromagnetic - Guidelines
RF Emission CISPR15	compliant	EDI LED head uses RF energy only for indoor operation. Therefore, its RF emissions are very low, and probably do not interfere with other electronic equipment nearby.
RF Emission CISPR15	compliant	EDI LED head is suitable for use in all buildings, including domestic buildings and those directly connected to the low voltage public electricity mains that power domestic buildings.
Harmonic emission	Class C	
Voltage fluctuations/flicker emission	compliant	

Recommended distances between portable and mobile radiocommunications devices and the dental unit

EDI LED head is designed to OPERATE in electromagnetic environment in which irradiating RF disturbances are under control. The client or operator of the unit can prevent electromagnetic interferences by ensuring a minimum distance between mobile and portable RF communication devices (transmitters) and the dental unit, according to the recommendations below, on the basis of the maximum output power of radiocommunications devices.

Maximum nominal output power of the transmitter W	Separation distance at transmitter frequency m		
	150 kHz to 80 MHz $d = 1,2 \sqrt{P}$	80 MHz to 800 MHz $d = 1,2 \sqrt{P}$	800 MHz to 2,5 GHz $d = 2,3 \sqrt{P}$
0,01	0,12	0,12	0,23
0,1	0,38	0,38	0,73
1	1,2	1,2	2,3
10	3,8	3,8	7,3
100	12	12	23

For transmitters with maximum nominal power emission which have not been listed above, the recommended separation distance d expressed in meters (m) can be calculated using the equation applied to the transmitter frequency, where P is the maximum nominal power emission of the transmitter expressed in Watts (W) according to its manufacturer.

Notes:

Apply the highest interval at 80 MHz and 800 MHz

These guidelines may not apply in all situations. Electromagnetic propagation is influenced by the absorption and reflection of structures, objects and people.

ELECTROMAGNETIC IMMUNITY

Manufacturer's guidelines and declaration – Electromagnetic immunity

EDI LED head is designed to operate in electromagnetic environments according to the specifications below. The client or user have to make sure the device is actually used in such environment

Immunity test	Conformity	Electromagnetic environment - Guidelines
Electrostatic discharge (ESD) IEC/EN61000-4-2	± 6kV contact ± 8kV air	The floor must be made from wood, concrete or ceramic tile. If floors are covered with synthetic material, the relative humidity has to be at least 30%.
Electrical fast transient/burst IEC/EN61000-4-4	± 2kV power supply ± 1kV for input/output lines	The value of network voltage has to be equivalent to that of a typical commercial or hospital environment.
Surge IEC/EN61000-4-5	± 1kV differential mode ± 2kV common mode	The value of network voltage has to be equivalent to the voltage of a typical commercial or hospital environment.
Voltage dips, short interruption and voltage variation IEC/EN61000-4-11	< 5% Ut for 0,5 cycle 40% Ut for 05 cycle 70% Ut for 25 cycle <5% Ut for 5 sec.	The value of network voltage has to be equivalent to the voltage of a typical commercial or hospital environment. If the user of EDI LED light requires continuous operation even in case of black outs, it is recommended to provide an uninterrupted power supply unit.
Power frequency magnetic field IEC/EN61000-4-8	3A/m	Level of the magnetic field at the typical frequency of a commercial or hospital environment.
Conducted immunity IEC/EN61000-4-6	3Vrms 150kHz to 80MHz (for non life-supporting equipment)	Portable and mobile RF communication devices cannot be used near any part of the dental unit, cables included, except when they comply with the recommended separation distances calculated by the equation applicable for the transmitter frequency. Recommended separation distances: d = 1,2√P d = 1,2√P from 80 MHz to 800 MHz d = 2,3√P from 800 MHz to 2,5 GHz Where P is the maximum nominal power emitted from the transmitter expressed in Watts (W), according to the transmitter manufacturer, and the recommended separation distance in meters (m). The intensity of the fixed RF transmitter field, as determined in an electromagnetic study of the site a, could be lower than the conformity level of each frequency interval. Interference can be checked near the devices provided with the following symbol:
Conducted immunity IEC/EN61000-4-6	3Vrms 80MHz to 2.5GHz (for non life-supporting equipment)	

Note: Ut is the value of the voltage

Note 1: Apply the highest frequency interval at 80 MHz and 800 MHz

Note 2: These guidelines may not apply in all situations. Electromagnetic propagation is influenced by the absorption and reflection of structures, objects and people.

a) The ISM bands (industrial, scientific and medical) between 150 kHz and 80 MHz are 6.765 MHz to 6.795 MHz; 13.553 MHz to 13.567; MHz 26.957 MHz to 27.283 MHz and 40.66 MHz to 40.70 MHz

b) The conformity levels of the ISM bands between 150kHz and 80MHz as well as the bands 80MHz to 2.5GHz can decrease if a portable transmitter causing interference is accidentally brought near a patient.

For this reason, an additional 10/3 factor has been added to the formula used to calculate the separation distance from transmitters.

c) Field intensities for fixed transmitters such as base stations for radio-telephones (cellular and cordless phones) and terrestrial transmitters, amateur radio stations, AM and FM radio transmitters and TV transmitters cannot be predicted theoretically and precisely. To establish an electromagnetic environment caused by fixed RF transmitters, carry out an electromagnetic investigation of the site. If the intensity of the field measured in the dental unit area of use is higher than the applicable

level of conformity previously given, it is necessary to monitor the lamp to ensure it works properly. If abnormal performance is detected, there could be necessary additional measures, such as different orientation or position of the lamp.

d) The field intensity in an frequencies interval from 150 kHz to 80 MHz has to be lower than 3 V/m.

FEATURES

Versions

- “EDI LED” head can be supplied in the following versions:
 - **Head with switch**
 - **Head with switch + automatic lighting function**
 - **Head with con proximity sensor**
 - **Head with switch + automatic lighting function**
- **Light source** consisting of two LEDs whose light is mirrored into two parabolic reflectors.
- **Reflecting surfaces** with parabolic reflectors which allow obtaining a regular uniform spot light at all lighting levels and to uniformly distribute the light in the operating field with no shadows or dark areas created by the operator.
- **Light intensity adjustment** using a mechanical switch or with a sensor.
- **Sensor** enables the light to be switched on or off without direct contact, eliminating therefore the possibility of cross-infection.
- **“Automatic lighting” function** allows the lamp to get switched on automatically whenever the power is enabled.
- Easy **maintenance** thanks to the application of new technology that takes into consideration various requirement in terms of safety, ergonomics and hygiene.
- **Removable handles for sterilization**
- **Front screen** lower significantly internal contamination of the device.
- **Electrical connection** - Follow the wiring diagrams

DESCRIPTION OF PARTS

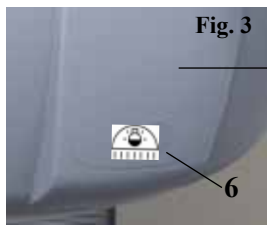

- 1 - On/Off switch (with or with no automatic lighting function)
Adjusting the light intensity
- 2 - Lens
- 3 - Parabola
- 4 - Handle
- 5 - Front screen
- 6 - Sensor (with or with no automatic lighting function)
Adjusting the light intensity
- 7 - Electronic board
- 8 - Wrench for front screen removal

SERIAL NUMBER OF THE DEVICE

All versions generated can be defined in a 9 digits code as described below:
50Z XYW 000

EDI LED identification number	Arms mechanics	Tested moving capacity	Control	Power supply	FARO outer layout serial number
5 0	Z	X	Y	W	0 0 0
0	Only head (no arm)	0 No head (only arm)	0 No board	0 Not used	
1	750 x 550 Unit/wall/floor mount	1 Standard	1 Switch	1 12-24 Vac 50/16Hz 17-33Vdc	
2	900 x 550 Unit/wall/floor mount	2 Third axis	2 Switch with automatic ON	2 120 Vac 60Hz (*)	
3	750 x 855 Unit/wall/floor mount		3 Proximity sensor	3 230 Vac 50Hz (*)	
4	900 x 855 Unit/wall/floor mount		4 Proximity sensor with automatic ON	4 240 Vac 50Hz (*)	
5	750 x 550 Ceiling mount				
6	900 x 550 Ceiling mount				
7	750 x 855 Ceiling mount				
8	900 x 855 Ceiling mount				

➤ Not available for ceiling, wall or floor installation versions

EDI LED Code table

The last 3 codes (currently 000) can vary in case of customized versions upon client’s requests. In the standard TPC certified product version it has always the value 000.

Code example for the 750x550 arm provided with “connection toward the ground” and 120 V transformer
501 002 000

Code example for three axis head with proximity On-Off switch
500 241 000

Code example for the 900x855 arm provided with “connection toward the sky”, standard head with On / Off Switch, powered at 12-24Vac- 17-33Vdc
508 121 000

INSTALLATION and CONNECTIONS

**DENTAL HEAD
“EDI LED”**



The device has to be installed by specialized technicians only
 Make sure all the components listed below have been included in the package received.

- Dental head (version according to order)
- Wrench for front screen removal (8 fig.4)
- Instruction manual



The device has to be cleaned prior to use
 (see “Cleaning the device” paragraph).



Cut off the power supply prior to installation.

ELECTRICAL CONNECTION HEAD - ARM

For the electrical connections refer to the wiring diagrams given in the manual.
 Always check the rating data prior to installation

ASSEMBLING THE HEAD TO THE ARM
 (see product identification table)

ASSEMBLY PHASE

INFORMATION

Follow the assembly sequence of the ring nut and washer indicated in the picture.

Proceed according to the description given

- Support the head and insert the washers (H), (L), (M).
- Screw the ring nut (G).

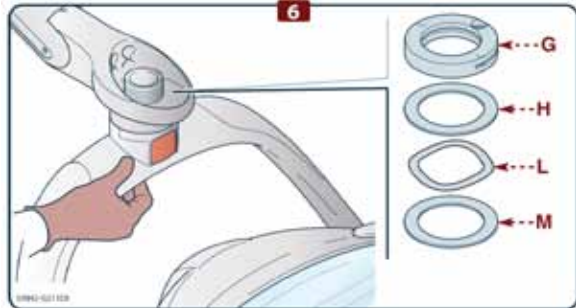

- Tighten the safety screw (F) until the proper head rotation resistance is obtained.

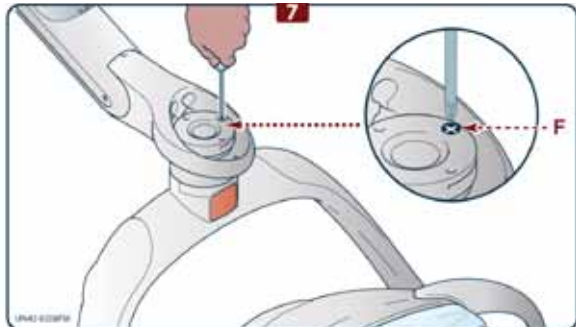

INSTRUCTIONS FOR USE

EDI LED head is used for lighting the oral cavity during surgery in dental practice. The optical parameters are obtained by positioning the lamp at 700 mm from the subject. At different distances the light spot could lose its optimum parameters in terms of size, homogeneity and lighting. It is therefore recommended to follow as much as possible the indicated distance.



Never use the head if any part thereof is faulty

SWITCH

(see components description at pag.8, fig.1)

SIMBOLS



ADJUSTING THE LIGHT INTENSITY



ON



OFF

Switch on

Switch off

“EDI LED” HEAD WITH SWITCH

(1 see components description at fig.1, pag.8)

Switch on / off / Adjustment

- To switch the lamp On and Off, press and release the push button to the left or right side. When the lamp is switched On / Off, the device will beep (once).
- **Adjustment:**
When switched on, the lamp is at its maximum lighting capacity.
To lower light intensity, keep the push button pressed to the left /right side until it reaches the required intensity.
When it reaches the **minimum intensity**, the device will beep once
- The adjustment goes from maximum to minimum light intensity.
- To go back to the maximum intensity, switch off and back on the lamp.



**The light intensity will be MAXIMUM each time it is switch on.
The push button has to be handled easily to avoid its breakage.**

“EDI LED ” AUTOMATIC TURN ON FUNCTION

The “automatic lighting” function allows the lamp to turn on automatically whenever the power is enabled.

“EDI LED” WITH SENSOR (Optional)

(6 see components description at fig.3, pag.8)



sensor

Switch on / off / Adjustment

- To switch On or Off , get near the sensor up to a maximum distance of 3 cm. When the lamp is switched on / off, the device will beep (once).
- To adjust the **light intensity**, stand still near the sensor until it is reached the wanted intensity, from the maximum to the minimum value.
- The adjustment goes from maximum to minimum light intensity.
- To go back to the maximum intensity, switch off and back on the lamp.

INSTRUCTIONS FOR USE

“EDI LED” HEAD WITH REMOTE CONTROL

The remote cable of the head has to be connected to the remote connector cable, which is connected to a switch placed on the push-button called “A” according to the diagram

Switch On / Off / Adjustment

- To switch the light on and off, press and release the push-button “A”
- Adjusting:
 - a) to lower the light intensity keep the push-button “A” pressed, until the desired intensity is obtained.
- When it reaches the minimum intensity, the device will beep (once).
- The adjustment goes from maximum to minimum light intensity.
- To go back to the maximum intensity, switch off and back on the lamp.

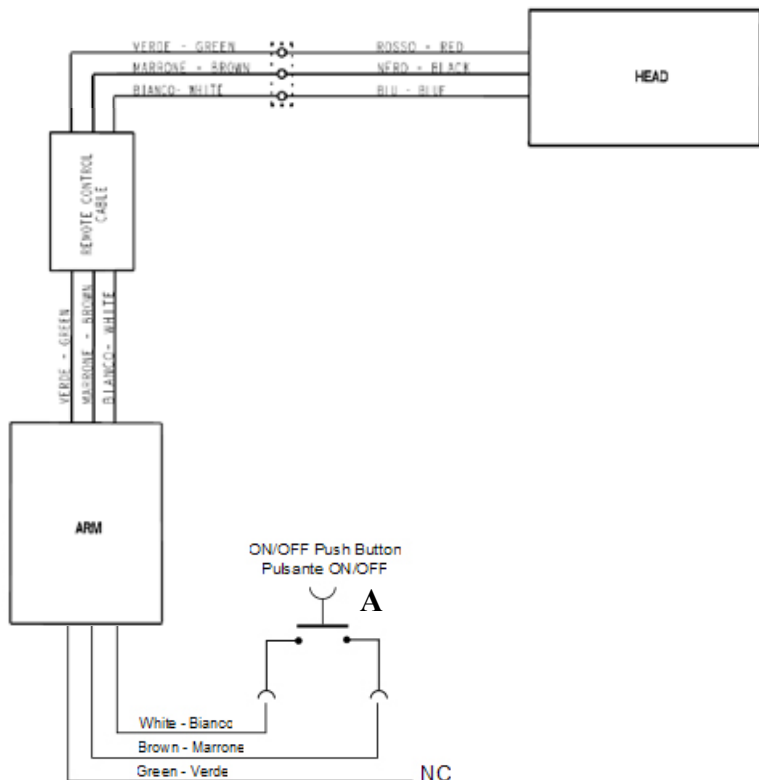

INSTRUCTIONS FOR USE

VIDEO - DIAGNOSTIC FUNCTION

The EDI LED lamp is provided with a function that allows using it during video shooting and / or during the usage of diagnostic tools (such as Diagnodent and laser) without any interference that could alter the outcome diagnostic.

The function is provided in both versions, with switch or with sensor, and it can be enabled or disabled by the user.

Enabling the Video-Diagnostic function

1. Switch on the lamp by means of the on/off switch
(one beep will be heard when the lamp is switched on)
2. Release the push button.
3. Lower the lamp to its minimum intensity by means of the same switch (a beep will be heard when the minimum intensity is reached) then, **without releasing it**, keep the button pushed for 4 seconds.
4. A confirmation beep will be heard, the intensity goes back to the maximum level and the Video - Diagnostic gets ENABLED.

If the function doesn't get enabled (step 4), repeat the procedure from step 1.

Disabling the Video-Diagnostic function

1. Switch on the lamp by means of the On/Off push button
(one beep will be heard when the lamp is switched on)
2. Release the button.
3. Lower the light to its minimum intensity by means of the same button (a beep will be heard when the minimum intensity is reached) then, **without releasing it**, keep the button pushed for 4 seconds.
4. A confirmation beep will be heard, the intensity goes back to the maximum level and the Video - Diagnostic gets DISABLED.

If the function doesn't get disabled (step 4), repeat the procedure from step 1.

Dimming the intensity while the Video - Diagnostic function is ENABLED:

When the Video-Diagnostics is enabled, the light intensity adjustment changes, from continuous variation to variation by steps.

Between maximum and minimum, there can be selected two intermediate levels of light intensity.

Procedure:

1. Switch on the light by means of the On/Off button (the device beeps when switched on).
2. Release the button.
3. Use the button to lower the light intensity and release it once reached intensity level wanted.

Note:

- When it reaches the minimum intensity, the device beeps.
- When the dental light is switched on, it will return to the maximum intensity level (it beeps once).

MAINTENANCE/CLEANING

REPLACING AND CLEANING THE FRONT SCREEN

(5 see components description at **fig. 2 pag.8**):

To remove the front screen from light proceed as follows:

- Rotate counter-clockwise the screws placed on the screen sides using the tool supplied
- Slip the screen out

To fit the screen back, carry out the same operations in reversed order.

Clean the screen using a soft cloth soaked in glass cleaner.

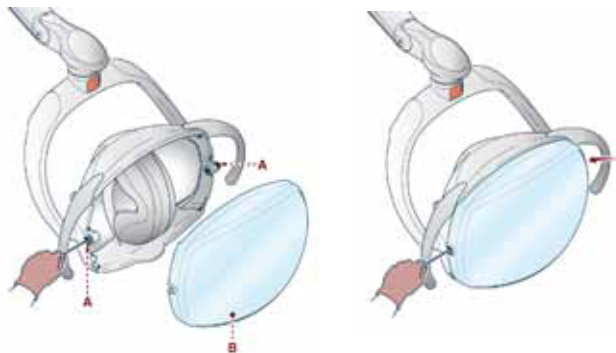

CLEANING THE PARABOLIC REFLECTORS (3 see components description at **fig. 2 pag.8**):

Remove the front screen “5” by rotating counter-clockwise the screws placed on the screen sides using the tool supplied.

For cleaning, use cotton wool and ethyl alcohol.

Do not use detergents containing surfactants or water repellent agents, since their residues create halos.



The hydroalcoholic disinfectants with 70% isopropyl or ethyl alcohol are suitable for cleaning. On cleaning the screen and parabolas, use gloves to avoid leaving halos on the surfaces.



WARNING: different cleaners could damage the parabolic reflectors
In case of doubts, refer to TPC.



Slight halos do not impair the quality of light.



For all parts of the head is strictly forbidden to use abrasives or detergents which contain alcohol, trichloroethylene, gasoline (petrol), turpentine or similar.



For cleaning plastic parts of the head **DO NOT USE** detergents - disinfectants which contain:

- AMMONIUM HYDROXIDE
- SODIUM HYDROXIDE
- METHYLENE CLORIDE
- METHYL ALCOHOL

Failure to follow this indication could cause:

- deterioration risk of plastic parts with consequent breakage

In case of doubts, refer to TPC Customer Assistance. 800 - 560 - 8222

STERILIZING THE HANDLES

To remove the handle, rotate counter-clockwise the knob “A”, then slip it until it gets out completely out from “B”.

To insert it, push firmly until abutted and rotate counter-clockwise the knob on “A”

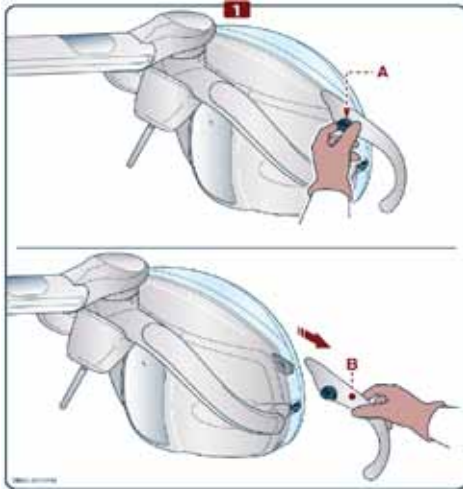

Handles are not supplied in sterile conditions; it must, therefore, be sterilized prior to use. Sterilize the handles with standard wet saturated steam cycles for a total of 200 sterilization cycles.

FOR STERILIZATION CARRY OUT TYPE “B” CYCLES ONLY, ACCORDING TO EN 13060.

Sterilization temperature C°	Minimum holding time min	Press kPa
121	15	207
134	3	308

CLEANING THE HEAD

Clean always with a soft cloth.



For all parts of the lamp it is strictly forbidden to use abrasives or detergents, which contain trichloroethylene, gasoline (petrol), turpentine or similar.

PERIODIC CHECKS

- Check readability of data on the rating plate (**annually**)
- Power safety check: (**every other year**)
 1. Insulation test according to EN62353
 2. Casing dispersion test
- Light checks: (**every five years or each 10,000 operating hours**)
 1. Maximum lighting intensity: >35000 lux.
 2. The value is obtained out of Blue light spectrum emitted measured in W / m²: <100



In case of abnormalities found during the periodic checks, refer immediately to TPC Customer Assistance.

ACOUSTIC SIGNALS

1 Beep = the maximum light intensity has been reached

1 Beep = at each command

1 Beep = when switched on

TROUBLE SHOOTING

- | | |
|-----------------------------------------------------------------|------------------------------------------------------------------------------------------------------------------------------------------------------------------------------------------------------|
| The light does not switch on | - Make sure the mains are disconnected. |
| The light intensity is considerably dimmed | - Clean the parabolic reflectors or the frontal screen.
If the light intensity does not return to initial values, consult Service Department. |
| The handles don't get locked or they are hard to unlock. | - Ensure the position of the fixing screw on the handle is fully open. |
| Halos on the parabolic reflectors | - Clean the surfaces with Isopropyl alcohol.
- The product used for cleaning or disinfection was not suitable and it has damaged the surface.
- Refer to TPC Customer Assistance. 800-560-8222 |

TECHNICAL FEATURES

Input voltage	12÷24Vac	17÷33Vdc
Frequency	50/60 hZ	-----
Power consumption	7 VA	5VA
Current consumption	510-290 mA	145-270mA
Protection against electrical hazards	Class II machinery	
Operation type	Continuous	
Maximum temperature on accessible surfaces	<71°C normal use conditions (plastic surfaces)	
Spot dimensions	100mm x 180 mm (*)	
Maximum illuminance	35,000 lux (standard) (*)	
Color temperature	5,000k (standard) (*)	
Environmental conditions for use	<ul style="list-style-type: none"> • Temperature from 100C to 400C • Relative humidity from 30% to 75% • Max. altitude: 2,000m • Atmospheric pressure from 800 mbar to 1,060 mbar 	

* Values measured at 700 mm between the light and the illuminated surface

ELECTRONIC BOARD

- THE PRODUCT IS VALID STARTING FROM VERSION FIRMWARE 2.0



F1- T3.15 AL 250V

The fuse can be replaced by TPC Service Department only